

Centre Number						Candidate Number				
Surname										
Other Names										
Candidate Signature										



General Certificate of Secondary Education
Foundation Tier
June 2013

Mathematics (Linear)

43652F

Paper 2

Friday 14 June 2013 9.00 am to 10.45 am

F

For this paper you must have:

- a calculator
- mathematical instruments.

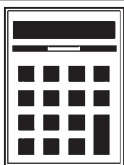

Time allowed

- 1 hour 45 minutes

Instructions

- Use black ink or black ball-point pen. Draw diagrams in pencil.
- Fill in the boxes at the top of this page.
- Answer **all** questions.
- You must answer the questions in the spaces provided. Do not write outside the box around each page or on blank pages.
- Do all rough work in this book.

Information

- The marks for questions are shown in brackets.
- The maximum mark for this paper is 105.
- The quality of your written communication is specifically assessed in Questions 6, 18 and 21. These questions are indicated with an asterisk (*).
- You may ask for more answer paper, tracing paper and graph paper. These must be tagged securely to this answer book.

Advice

- In all calculations, show clearly how you work out your answer.

For Examiner's Use	
Examiner's Initials	
Pages	Mark
2–3	
4–5	
6–7	
8–9	
10–11	
12–13	
14–15	
16–17	
18–19	
20–21	
22–23	
24–25	
26–27	
28–29	
30	
TOTAL	



J U N 1 3 4 3 6 5 2 F 0 1

WMP/Jun13/43652F

43652F

Formulae Sheet: Foundation Tier

Area of trapezium = $\frac{1}{2}(a+b)h$

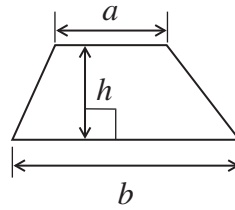

Volume of prism = area of cross-section \times length

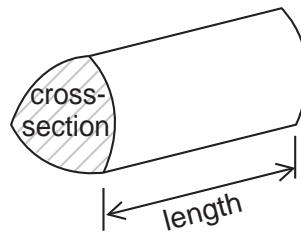

Answer **all** questions in the spaces provided.

1 *O* is the centre of the circle.

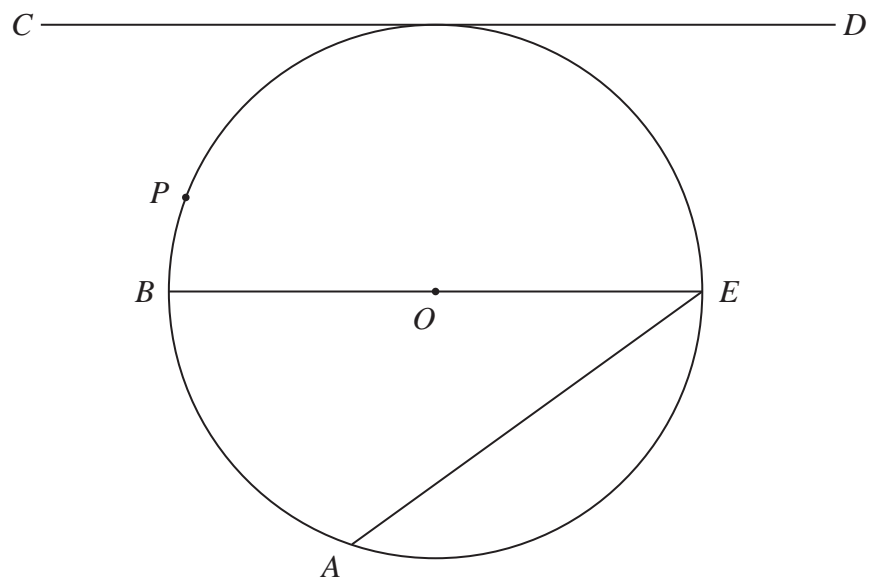

Here are five words.

- circumference chord tangent diameter radius**

Choose a word to complete each of these sentences.

BE is a

Point *P* lies on the

CD is a

AE is a

(4 marks)

4

Turn over ►



2 (d) Work out the area of shape *ABCDEF*.
State the units of your answer.

.....

.....

.....









Answer (3 marks)

Turn over for the next question



3 The pictogram shows the number of goals scored by Alex and Jack.

Key  represents 2 goals

Alex	   
Jack	    
Lee	

3 (a) How many goals has Alex scored?

Answer (1 mark)

3 (b) Lee scored 6 goals.

Complete the pictogram.

(1 mark)

3 (c) In the next match, Jack scores all the goals.
In total, he has now scored **twice** as many goals as Lee.

How many goals did Jack score in this match?

.....
.....

Answer (3 marks)



- 4 A , B and C are plotted on this centimetre grid.

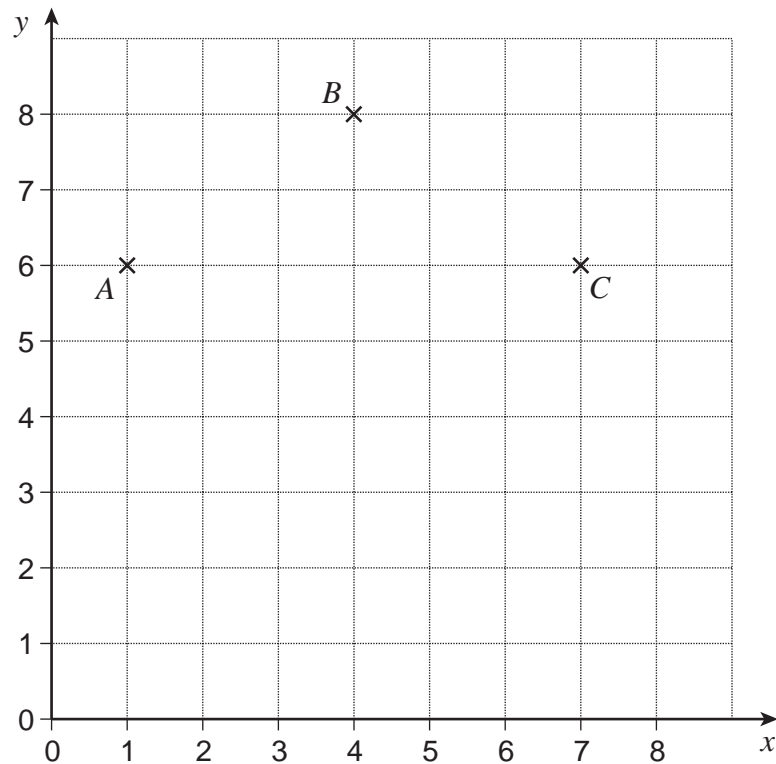

- 4 (a) Write down the coordinates of A .

Answer (..... ,)

(1 mark)

- 4 (b) Write down the coordinates of the midpoint of AC .

Answer (..... ,)

(1 mark)

- 4 (c) Plot a point D on the grid so that $ABCD$ is a kite.

(1 mark)



5 Here are some numbers.

18

32

42

68

81

5 (a) Which number is a multiple of 7?

Answer (1 mark)

5 (b) Which **two** numbers add up to 100?

Answer and (1 mark)

5 (c) Which number is a square number?

Answer (1 mark)

5 (d) Which number is a factor of 64?

Answer (1 mark)



6 Use your calculator to work out

6 (a) $12.45 - 3.6$

Answer (1 mark)

6 (b) $30 \div 2.4$

Answer (1 mark)

***6 (c)** 25% of £98

.....

Answer £ (2 marks)

Turn over for the next question



BOB's Autos
For a repair we charge

Hours worked × £ 18
 +
Cost of parts

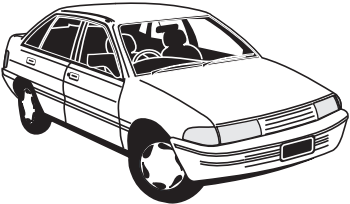

7 (a) Work out the charge for a repair when

Hours worked = 3

Cost of parts = £ 110

.....

.....

Answer £ (2 marks)

7 (b) Complete this table for another repair.

Cost of repair	Hours worked	Cost of parts
£ 240		£ 150

(3 marks)



8 (a) Josh has these six coins.



He buys a sandwich for £ 1.95
He gets **one** coin in change.

What coins does he have now?

Answer and (2 marks)

8 (b) Sam has an equal number of 5 p and 10 p coins.
Altogether, she has 90 p.

How many 5 p coins does she have?
You **must** show your working.

Answer (3 marks)

10

Turn over ►



9 Arrange these numbers in order of size starting with the smallest.
You **must** show your working.

27%

0.207

$\frac{56}{200}$

.....
.....
.....

Answer , , (2 marks)



10 The diagram shows a cuboid.

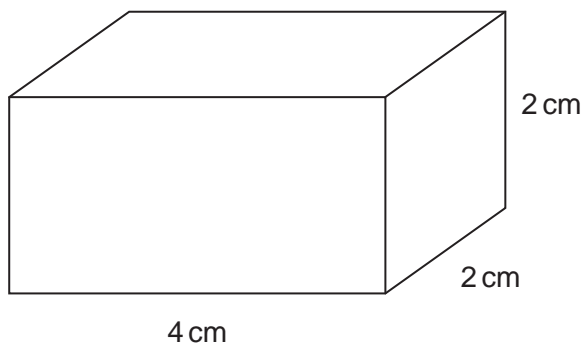

Draw an accurate net of the cuboid on this centimetre grid.



(3 marks)

5

Turn over ►



11 Here is a number machine.

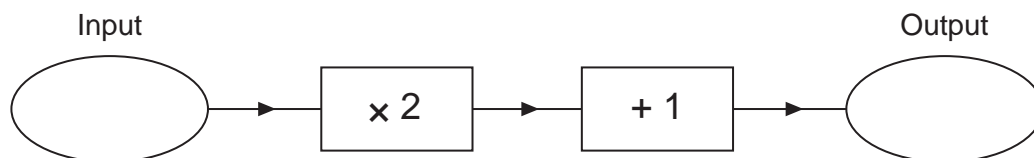

11 (a) Work out the **output** when the input is 12.

Answer (1 mark)

11 (b) Write down an expression for the **output** when the input is n .

Answer (1 mark)

11 (c) Work out the **input** when the output is 49.

Answer (2 marks)



12 DVD cases are packed in this box.

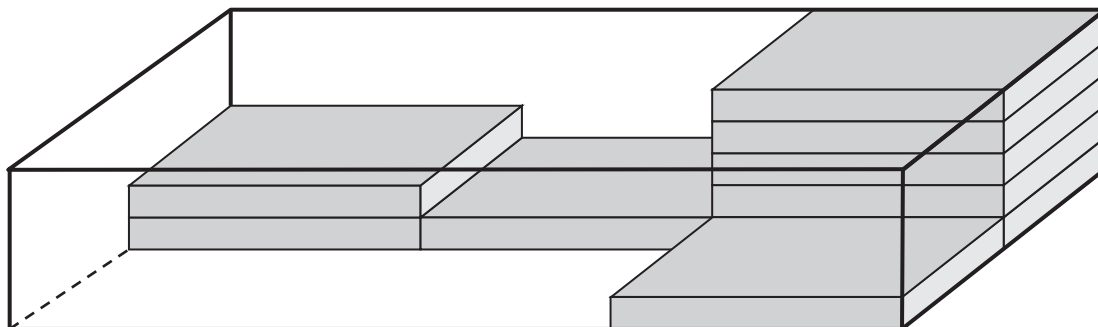

12 (a) How many cases are there in a **full** box?

.....

.....

.....

Answer (2 marks)

12 (b) A full box of cases costs £2.70

Work out the cost of one case.

.....

.....

Answer pence (2 marks)



13 Here are six rods.

1 cm

2 cm

3 cm

4 cm

5 cm

9 cm

On this grid, show how a rectangle can be made using **all** the rods.

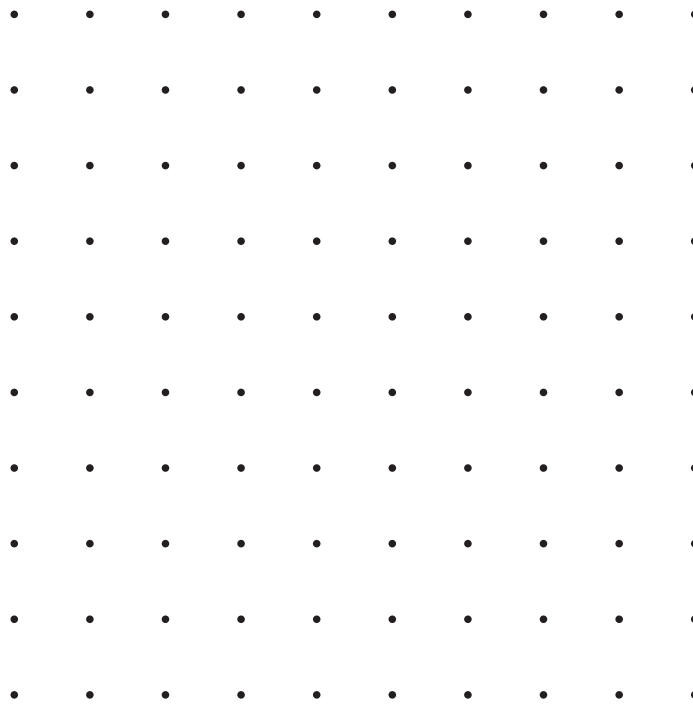

(2 marks)



14 (a) Work out the size of angle x .

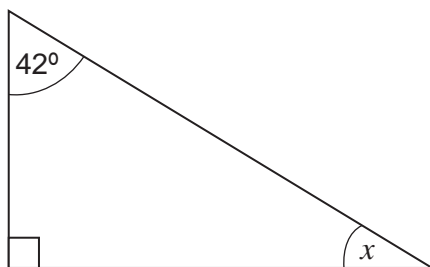

Not drawn accurately

.....

.....

Answer degrees (2 marks)

14 (b) Work out the size of angle y .

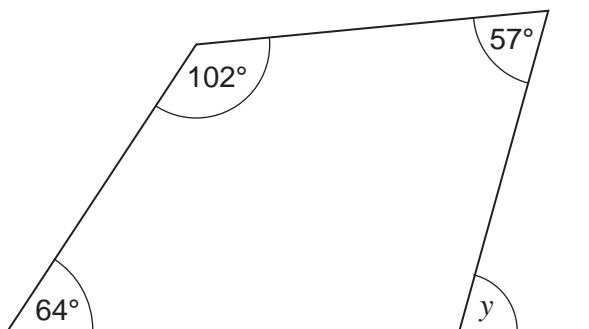

Not drawn accurately

.....

.....

.....

Answer degrees (3 marks)

7

Turn over ►



15 The stem-and-leaf diagram shows the ages of people at a show.

Key: 2 | 3 represents 23 years

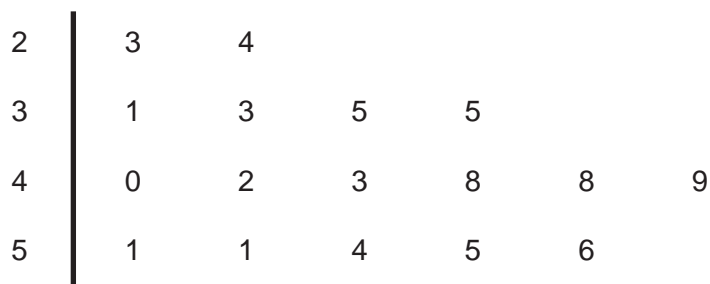

15 (a) What is the range of the ages?

Answer years (1 mark)

15 (b) How many people are represented in the stem-and-leaf diagram?

Answer (1 mark)

15 (c) How can you tell from the stem-and-leaf diagram that the median is 43 years?

.....

(1 mark)



15 (d) The age of another person is added to the stem-and-leaf diagram.
The median increases by 2 years.

What is the age of this person?

Answer years (1 mark)

Turn over for the next question

4

Turn over ►



16

The table shows where 72 people went on holiday.

Spain	36	
Portugal	18	
Turkey	6	
Other	12	
	Total = 72	

Draw a fully labelled pie chart for the data.

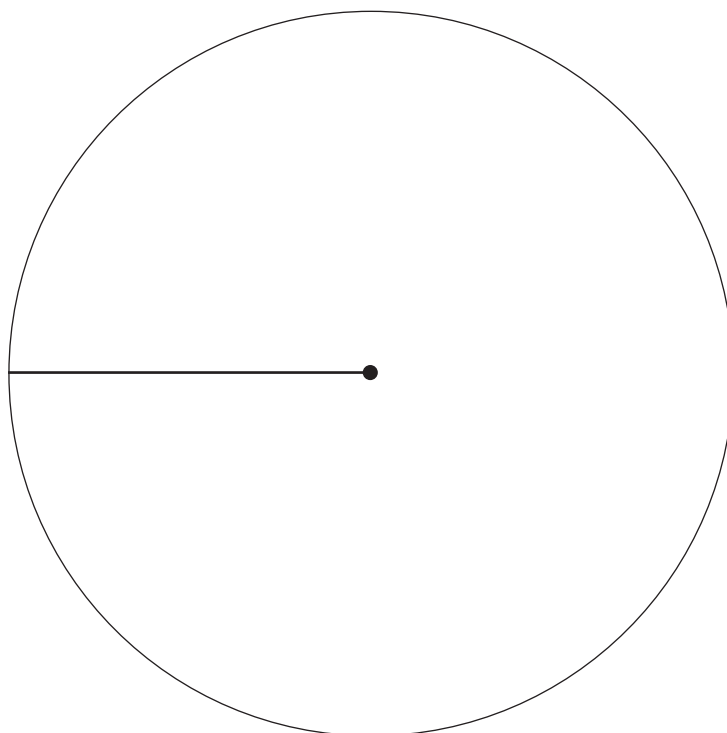

(4 marks)



17 Liz wants to drink 1.5 litres of water each day.
She buys the water in packs of 6 bottles.
Each bottle contains 0.5 litres of water.



How many packs of water does she need to buy for 10 days?
You **must** show your working.

.....

.....

.....

.....

.....

Answer (4 marks)

Turn over for the next question



***18**

Here is part of a shopping bill for grapes and apples.

0.5 kg of grapes at	=
2 kg of apples at £1.25 per kg	=
Total to pay	=
Paid	= £ 10
Change	= £ 5.40

Work out the price of 1 kg of grapes.

.....

.....

.....

.....

.....

.....

Answer £ (5 marks)



19 (a) Simplify fully $4x + 7y + 5x - y$

.....
.....

Answer (2 marks)

19 (b) Multiply out $4(x + 3)$

.....

Answer (1 mark)

19 (c) Factorise $x^2 - 5x$

.....

Answer (1 mark)

Turn over for the next question



20 The scatter diagram shows the scores of 10 students in their Oral and Written tests.

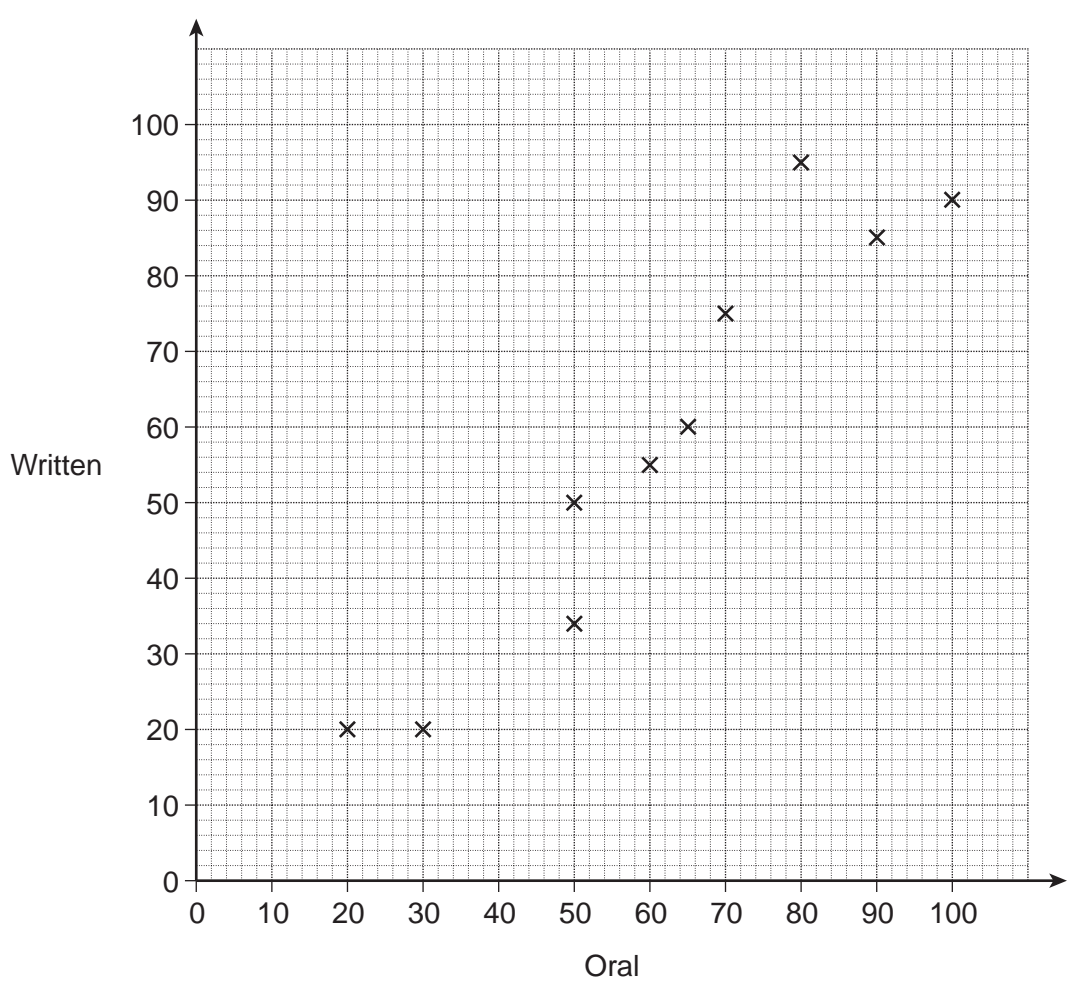

20 (a) How many students scored 50 in their Oral test?

Answer (1 mark)

20 (b) Four more students take the same tests. The table shows their scores.

Oral	10	94	52	84
Written	15	90	46	80

Plot the scores on the scatter diagram. (2 marks)



20 (c) Draw a line of best fit on the scatter diagram. (1 mark)

20 (d) Rob scored 40 in the Oral test.
He was absent for the Written test.

Use your line of best fit to estimate a score for him in the Written test.

Answer (1 mark)

***21** Here are two ways of having a car for one year.

Buy and sell

Buy it for £ 12 000

Sell it for £ 10 000 after one year

Rent

Normal Price: £ 195 per month

Special Offer 15% off

Which way is cheaper?
You **must** show your working.

.....
.....
.....
.....
.....
.....
.....

Answer (5 marks)

10

Turn over ►



22 (a) A speed camera takes two photographs of a car.

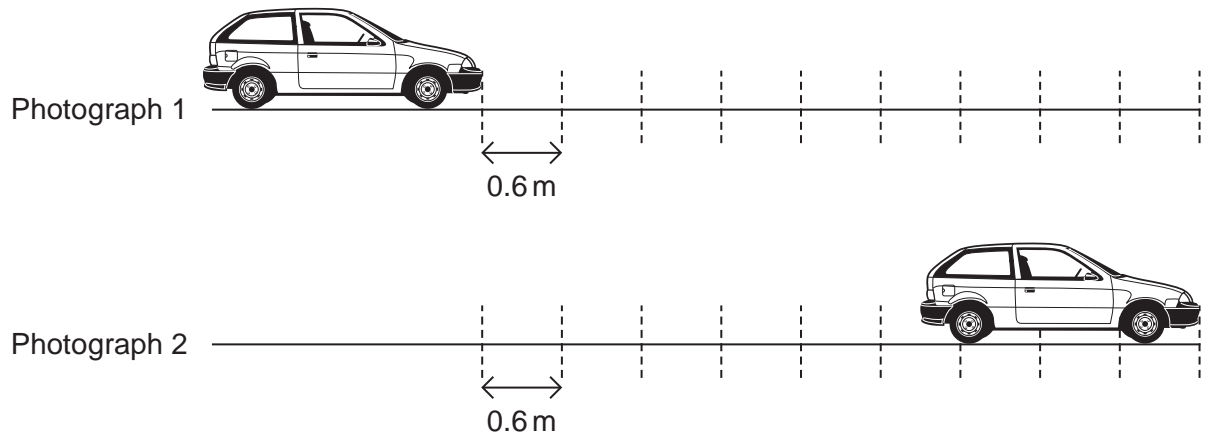

Photograph 2 was taken 0.5 seconds after Photograph 1.
Marks on the road are 0.6 metres apart.

Calculate the average speed of the car in m/s.

.....
.....
.....

Answer m/s (3 marks)



22 (b) You are given that

$$1 \text{ kilometre} = 1000 \text{ metres}$$

and

$$1 \text{ hour} = 3600 \text{ seconds}$$

A lorry is travelling at 13.6 m/s.
The speed limit is 50 km/h.

Show that the lorry is travelling below the speed limit.

.....

.....

.....

.....

(3 marks)

Turn over for the next question

6

Turn over ►



23

150 boys and 160 girls sit an examination.
The table shows some of the probabilities that they came with or without a calculator.

	With calculator	Without calculator
Boy	0.92	0.08
Girl	0.95	

23 (a)

What is the probability that a girl came **without** a calculator?
Write your answer in the table.

(1 mark)

23 (b)

How many of the 150 boys came **with** a calculator?

.....

.....

.....

.....

.....

Answer

(2 marks)



24 The perimeter of this square is 48 cm.

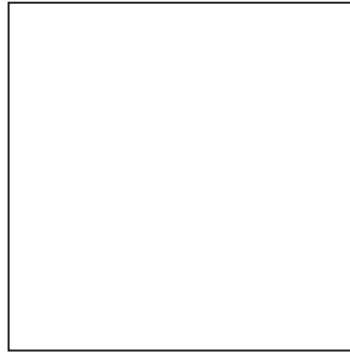

Semicircles are joined to two sides of the square.

Not drawn
accurately

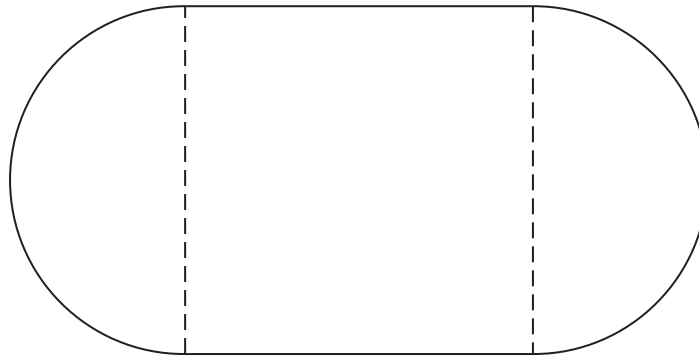

Work out the perimeter of this shape.

.....

.....

.....

.....

.....

.....

Answer cm (4 marks)

7

Turn over ►



25 Amy raised £ n for charity.
Chris raised £ 18 more than Amy.

The **mean** amount raised by the two of them is £ 45.

Work out how much money each one of them raised.

.....

.....

.....

.....

.....

.....

.....

.....

Amy £

Chris £ (5 marks)

END OF QUESTIONS

5



There are no questions printed on this page

**DO NOT WRITE ON THIS PAGE
ANSWER IN THE SPACES PROVIDED**



There are no questions printed on this page

**DO NOT WRITE ON THIS PAGE
ANSWER IN THE SPACES PROVIDED**

